



DESIGNED FOR
OPEN PLAN LIVING.



Tasty and Healthy



VITAMIN C increasing by 10%*¹
Stimulates the food manufacturing process (Photosynthesis)

	▶	
Conventional 2011 model (MR-RX62T)		Mitsubishi Electric's Vitamin Factory

VITAMIN FACTORY

Vitamin Factory acts on chlorophyll in vegetables. It stimulates the food manufacturing process (photosynthesis) and increase the vitamin content of vegetables with the ultimate aim of keeping vegetables greener and fresher.

The triple-coloured LED light which help to increase vitamins 1.5 times acts as "miniature sun" to help promote longer-lasting freshness, sustain nutrients and increase vitamins in vegetables.

HUMIDITY CONTROL

The vegetable drawer features humidity controls to regulate the amount of moisture in the crisper.





● EASILY STORE LARGE ITEMS

Large items that cannot fit in before can now be stored easily without having to take food out for arrangements.

● EFFICIENTLY USES THE UPPERMOST AREA

Easy to handle even for petite woman as the shelves can be lowered down easily.

● SECURE SHELF SPACE

A higher space can be achieved without shelf-folding, which allows the smaller shelf to still be used.

3-WAY FLEXISHELF

Our 3-Way flexishelf enables you to easily remove shelves in our refrigerators to accommodate your storing needs.



TEMPERED GLASS SHELF

Every compartment in our refrigerator shares a spacious storage area. Our shelves are made from safety tempered glass. Up to 100kg (max)



Very tough glass shelves can load up to 100kg (max)

DOUBLE ANTI-BACTERIAL FOOD LINER

A silvery inorganic anti-bacterial material, it is used in the inner cabinet of the refrigerator. The material conforms to the Japanese food sanitation law and is harmless to the human body if ingested.



3rd party institute has tested the effects. We started with 340,000 colon bacillus on 2 plastic material. After 24 hours, ordinary plastic gets 11 bacterial but anti-bacteria plastic has only 1,300 bacteria.



SURROUND MULTI AIR-FLOW SYSTEM

Mitsubishi Innovative Surround Multi Air-Flow System distributes uniform cooling air via 6 temperature regulating points in the refrigerator, to all shelves, even hard-to-cool places such as filled door pockets.

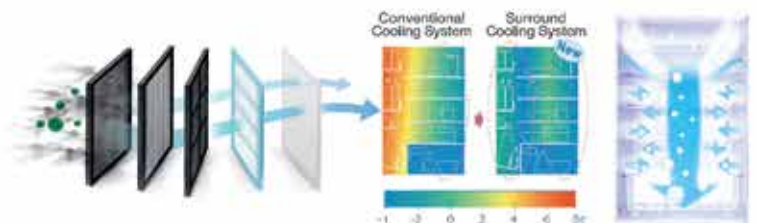

The major purpose of MINUS ION is to increase moisture inside the fridge & to preserve nutritional value of food.

THE UNI-GLASS (*for selected models only)

Lighter than glass door and easier to carry if it need of changing position. Plus, it gives the refrigerator a more luxurious image with glossy look.



Silver Wave Line (SLW)



Brown Wave Line (BRW)

One Door



MR-18PA 180L

Dimension (mm)
555 (W) x 1214 (H) x 596 (D)

Weight (kg)
38

Gross Capacity

R
Refrigerator Compartment
180 Litres

Main Features:

- Anti Bacteria Door Gasket
- CFC Free
- Minus Ion
- Uni Chilled Case

COLOURS



Silver



Black



SINGLE DOOR *Smart, Compact, Beautiful*

Our smart, compact all-in-one freezer and refrigerator units with a Uni-Chilled Case that can be folded to fit larger items are the ultimate in one-stop refrigeration.

Freezer



FREEZER *A Cooler Alternative*

Our Proprietary Rapid Cool technology ensures that usual, saving energy and making our freezers the temperature drops dramatically to cool things faster cooler alternative for additional storage.

MF-U16J-W-ML1 144L

Dimension (mm)
480 (W) x 1291 (H) x 586 (D)

Weight (kg)
41

Gross Capacity

F
Freezer Compartment
160 Litres

Main Features:

- Anti Bacteria Door Gasket
- Frost Free
- CFC Free
- Rapid Freezer Mode

COLOURS



White

Feature Multi Fan

Mitsubishi innovative surround multi air-flow system distributes uniform cooling air via 6 temperature regulating points in the refrigerator, to all shelves, even hard-to-cool places such as filled door pockets. Class cool air with Negative-Ion to hinder the growth of bacteria and is emitted from all sides to create surround cooling, keeping food fresh longer.



INTERNAL COOLING FAN

Provides 3 speed cooling levels for both surroundcooling and multi airflow system.

NEURO ELECTRONIC DAMPER

If the temperature in R-room is higher than 30C the damper will automatically open to let the air from F-room flow down to balance the temperature inside R-room. The system is more stable than Thermo Damper.

OUTER FAN

Helps in cooling down compressor heating and making more efficiency operation by using less energy consumption.



MASTER OF TECHNOLOGY

Innovation caters to the lifestyle of new generation with integration of high technology for better efficiency and convenience usage.



MASTER OF DURABILITY

We think, create, and plan for every production. In addition of usage of high quality materials, our products have been long in accepted quality and durable use.



MASTER OF ENERGY SAVING

In Mitsubishi Electric, we are always concerned about the energy saving is not just about help saving cost, but decreases usage of any unnecessary resources.

2 Doors

MR-FS51ES 413L

Top Freezer
Dimension (mm)
699 (W) x 1820 (H) x 735 (D)

Weight (kg)
86

Gross Capacity

F
Freezer Compartment
102 Litres

R
Refrigerator Compartment
311 Litres

Main Features:

- Anti Bacteria Food Liner
- Multi Air Flow
- Minus Ion
- Frost Free
- Vitamin Factory
- Door Alarm
- Tempered Glass Shelves
- Neuro Inverter System
- Deodorizer (Filter With Blue Catalyst)

COLOURS



MR-F62EG 560L

Top Freezer
Dimension (mm)
751 (W) x 1777 (H) x 795 (D)

Weight (kg)
93

Gross Capacity

F
Freezer Compartment
178 Litres

R
Refrigerator Compartment
382 Litres (F62EG)

Main Features:

- Anti Bacteria Food Liner
- Multi Air Flow
- Minus Ion
- Frost Free
- Vitamin Factory
- Tempered Glass Shelves
- Neuro Inverter System

COLOURS

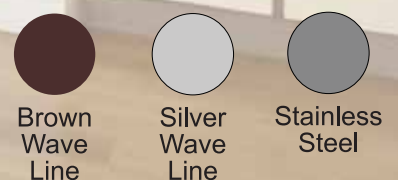

2 Doors FC Series



MR-FC25EP
236L

Top Freezer

Dimension(mm)
555 (W) x 1378 (H) x 672 (D)

Weight (kg)
47

Gross Capacity

F
Freezer Compartment
77 Litres

R
Refrigerator Compartment
159 Litres

Main Features:

- Anti Bacteria Food Liner
- Anti Bacteria Door Gasket
- Frost Free
- Tempered Glass Shelves
- Neuro Inverter System
- Deodorizer



MR-FC29EP
263L

Top Freezer

Dimension(mm)
555 (W) x 1476 (H) x 662 (D)

Weight (kg)
50

Gross Capacity

F
Freezer Compartment
77 Litres

R
Refrigerator Compartment
186 Litres

Main Features:

- Anti Bacteria Food Liner
- Anti Bacteria Door Gasket
- Frost Free
- Tempered Glass Shelves
- Neuro Inverter System
- Deodorizer



MR-FC34EP
309L

Top Freezer

Dimension(mm)
555 (W) x 1693 (H) x 662 (D)

Weight (kg)
54

Gross Capacity

F
Freezer Compartment
87 Litres

R
Refrigerator Compartment
222 Litres

Main Features:

- Anti Bacteria Food Liner
- Anti Bacteria Door Gasket
- Frost Free
- Tempered Glass Shelves
- Neuro Inverter System
- Minus Ion
- Door Alarm
- Deodorizer



MR-FC37ER
314L



Top Freezer

Dimension(mm)
635 (W) x 1498 (H) x 701 (D)

Weight (kg)
60

Gross Capacity

F
Freezer Compartment
103 Litres

R
Refrigerator Compartment
211 Litres

Main Features:

- Anti Bacteria Food Liner
- Anti Bacteria Door Gasket
- Frost Free
- Tempered Glass Shelves
- Neuro Inverter System
- Minus Ion
- Door Alarm
- Deodorizer



2 Doors FX Series

Energy Efficiency

Neuro Inverter System controls the Neuro Fuzzy Microprocessor, inverter compressor, and fan speed. Neuro Fuzzy can adjust to the most suitable operation and memorize the household's usage pattern through various time frames to automatically operate the refrigerator in optimal condition.



MR-FX43EN

Dimension (mm)
699 (W) x 1620 (H) x 720 (D)

Gross Capacity
389 Litres

Net Capacity
331 Litres

Main Features:

- Vitamin Factory
- Glass Door
- Anti Bacteria Food Liner
- Anti Bacteria Door Gasket
- Multi Airflow
- Deodorizer
- Frost Free
- Tempered Glass Shelves
- Neuro Inverter System
- Minus Ion
- Door Alarm

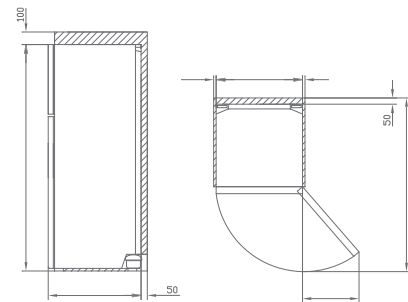

COLOURS



Glass Stellar Silver

Glass Brilliant Black



MR-FX47EN

Dimension (mm)
699 (W) x 1720 (H) x 720 (D)

Gross Capacity
421 Litres

Net Capacity
362 Litres

Main Features:

- Vitamin Factory
- Glass Door
- Anti Bacteria Food Liner
- Anti Bacteria Door Gasket
- Multi Airflow
- Deodorizer
- Frost Free
- Tempered Glass Shelves
- Neuro Inverter System
- Minus Ion
- Door Alarm

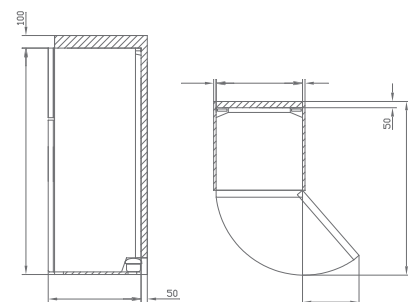

3 Doors CGX Series

COLOURS

-  Glass Antique Brown
-  Glass Brilliant Black



MR-CGX56EP-ML

Dimension (mm)

699 (W) x 1798 (H) x 709 (D)

Gross Capacity

492 Litres

Net Capacity

361 Litres

Main Features:

- Automatic Ice Maker
- Supercool Chilling Case
- Vitamin Factory
- Glass Door
- Multi Airflow
- Deodorizer
- Frost Free
- Tempered Glass Shelves
- Neuro Inverter System
- Minus Ion
- Door Alarm

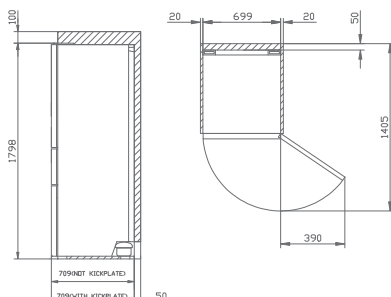

MR-CGX46EN-ML

Dimension (mm)

600 (W) x 1820 (H) x 660 (D)

Gross Capacity

402 Litres

Net Capacity

298 Litres

Main Features:

- Automatic Ice Maker
- Supercool Chilling Case
- Vitamin Factory
- Glass Door
- Multi Airflow
- Deodorizer
- Frost Free
- Tempered Glass Shelves
- Neuro Inverter System
- Minus Ion
- Door Alarm

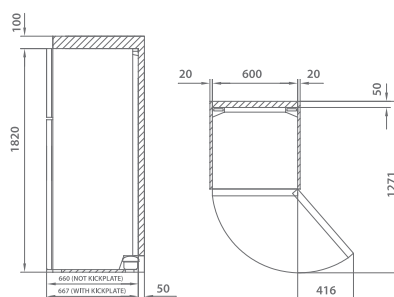

MR-CGX41EN-ML

Dimension (mm)

600 (W) x 1698 (H) x 660 (D)

Gross Capacity

370 Litres

Net Capacity

266 Litres

Main Features:

- Automatic Ice Maker
- Supercool Chilling Case
- Vitamin Factory
- Glass Door
- Multi Airflow
- Deodorizer
- Frost Free
- Tempered Glass Shelves
- Neuro Inverter System
- Minus Ion
- Door Alarm

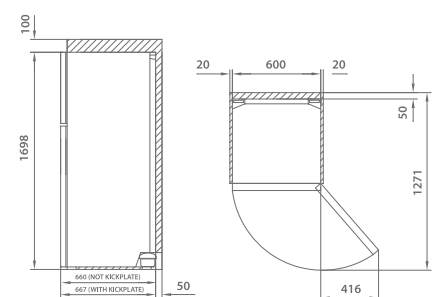

4 Doors Features

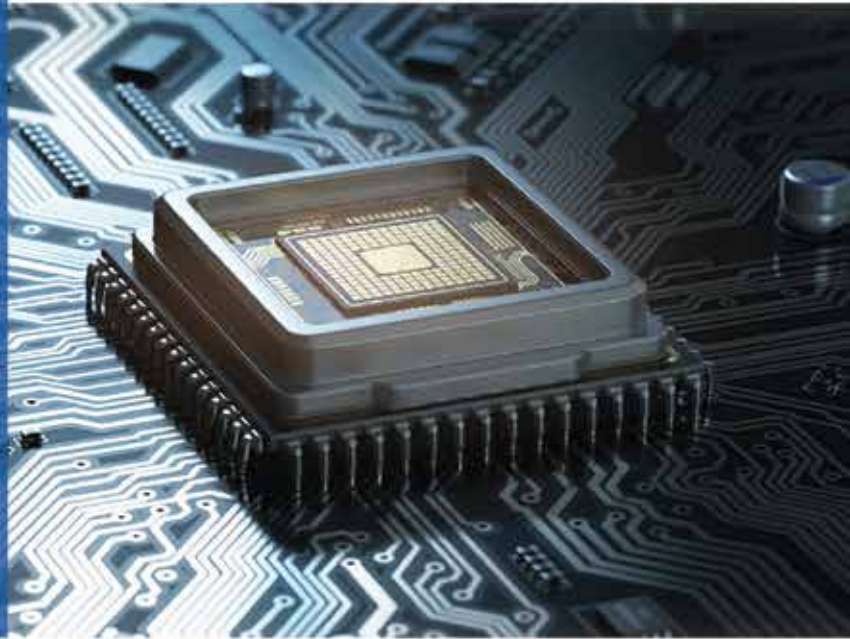

THE NEURO FUZZY SYSTEM

Memorizes the household's usage patterns through various time frames to automatically operate the most optimal conditions by microprocessor. In other words, Neuro Fuzzy can adjust the best operating for your household's usage.

AUTOMATIC ICE MAKER

The non-plumbed automatic ice maker produces a continuous supply of ice cubes with just a simple refilling the water into a separate water tank. It removes the load of having to refill ice trays whenever they get empty. In addition, most the parts can be easily removed for cleaning.

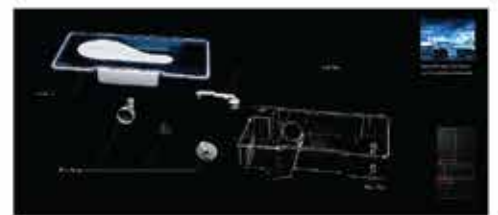

SUPERCOOL CHILLING CASE

With the sub-zero cooling technology, ones could eliminate the constant issue of freezer burn and hassle of defrosting food for food preparation. This feature is designed for storing meat, fish and other perishable foods at the temperature between -3C to 0C, prevents complete freezing and food is ready to cook without the need to defrost it.



ERGONOMIC & SPACIOUS DRAWER DESIGN

Specially Designed To Suit Your Lifestyle

With a more frequent usage of refrigerator compartment in everyday life, the refrigerator compartment is designed to be at the top for easy access and reduces bending of body. The drawer design comes with a dual shelf for extra space of storage, makes organization even easier.









ENERGY EFFICIENCY

Neuro Fuzzy Inverter Technology memories your life patterns while constantly monitors the temperature within the refrigerator. It then will automatically adjust the power and running speed of the compressor accordingly to ensure an optimum and a quieter operation.



Specification For Malaysia

Refrigerator Type		Freezer	1 Door	2 Doors Top Freezer							
Model		MF-U16J	MR-18PA	MR-FC25EP	MR-FC29EP	MR-FC34EP	MR-FC37ER	MR-FX43EN	MR-FX47EN	MR-FS51ES	
MEPS Rating											
Capacity (Litre) [ISO standard]	Freezer Compartment	Net	-	-	64	64	72	103	95	95	102
		Gross	144	-	77	77	87	-	123	123	-
	Refrigerator Compartment	Net	-	-	153	179	216	211	236	267	311
		Gross	-	180	159	186	222	-	266	298	-
	Vegetable Compartment	Net	-	-	-	-	-	-	-	-	-
		Gross	-	-	-	-	-	-	-	-	-
Total	Net	-	-	217	243	288	314	331	362	413	
	Gross	144	180	236	263	309	-	389	421	-	
Dimension (mm.)	Width		480	555	555	555	555	635	699	699	699
	Height		1291	1214	1378	1476	1693	1498	1620	1720	1820
	Depth (Not Handle)		386	396	672	662	662	701	720	720	735
	Depth (With Handle)		-	-	-	-	-	-	-	-	-
Weight (kg.)	Net		38	34	42	45	49	55	73	76	77
	Gross		41	38	47	50	54	60	82	86	86
Cooling		Fan Cooling	Direct Cool	-	-	-	-	Multi Airflow			
Frost Free		●	Semi-Auto	●	●	●	●	●	●	●	
CFC Free		●	●	●	●	●	●	●	●	●	
Anti-bacteria Food Liner		-	-	●	●	●	●	●	●	●	
Anti-bacteria Door Gasket		●	●	●	●	●	●	●	●	●	
Deodorizer		-	-	●	●	●	●	Filter	Filter	Filter	
Minus Ion		-	●	-	-	●	●	●	●	●	
Vitamin Factory		-	-	-	-	-	-	●	●	●	
Door Alarm		-	-	-	-	●	●	●	●	●	
Neuro Inverter System		-	-	●	●	●	●	-	-	●	
Supercool Chilling		-	-	-	-	-	-	-	-	-	
Glass Door		-	-	-	-	-	-	●	●	-	
Colour	Silver		SL		SL		SL			SSL	
	Brown			BR	BR	BR	BR			BR	
	Onyx Black		OB	OB	OB	OB					
	Shiny Black										
	Hairline Silver										
	Silver Wave Line										
	Stainless Steel										
	Brown Wave Line										
	Pure White										
	Glass Brilliant Black							GBK	GBK		
	Glass Stellar Silver							GSL	GSL		
White											

Remarks:*Gross Capacity based on AS standards (Australia) **Net Capacity based on JIS Standards (Japan)
 These Mitsubishi Refrigerator products have been type-tested and considered as being in compliance with the safety requirement of the Standard (IEC 335-2-24: 1984 & Amendment 1:1987 ISO: 15502) and hence approved the entered into the register of Approves Controlled Goods, pursuant to the Consumer Protection (Safety requirements) Regulation 1991. The registration is not an endorsement of quality control systems which are part of the manufacturing process.

Specification For Malaysia

3 Doors Bottom Freezer			2 Doors Top Freezer	4 Doors Drawer Style Bottom Freezer	4 Doors French Style Bottom Freezer
MR-CGX41EN-ML	MR-CGX46EN-ML	MR-CGX56EP	MR-F62EG	MR-LX68EM	MR-LA78ER
-	-	-		-	-
55	55	74	144	94	179
104	104	133	178	180	-
167	199	232	357	295	456
189	221	262	382	333	-
44	44	55	-	67	-
77	77	97	-	117	-
266	298	361	501	456	635
370	402	492	560	630	-
600	600	699	751	900	950
1698	1820	1798	1777	1798	1818
660	660	709	795	735	769
667	667	709	-	-	-
67	71	85	84	110	124
75	79	94	93	123	137
Multi Airflow	Multi Airflow	Multi Airflow	Multi Airflow	Multi Airflow	Twin Fan Multi Airflow
•	•	•	•	•	•
•	•	•	•	•	•
-	-	-	•	•	•
-	-	-	•	•	•
Filter	Filter	Filter	Filter		Filter
-	-	-	•	-	-
•	•	•	•	•	•
•	•	•	•	•	•
•	•	•	-	•	•
•	•	•	-	•	-
•	•	•	-	•	•
OB	OB	OB	SLW		
PWH	PWH	PWH	ST	GBK	
			BRW	GSL	
					GBK
					WH

* Some features are only available on certain models. Kindly refer to product specification for further information. * All the image used are for illustration purpose only.

* Specification and designs are subject to change without notice.

4 Doors

“It’s Time To Live Large”

MR-LA78ER

Dimension (mm)
950 (W) x 1818 (H) x 769 (D)

Net Capacity
635 Litres

Main Features:

- Automatic Ice Maker
- Anti Bacteria Food Liner & Door Gasket
- Vitamin Factory
- Door Alarm
- Twin Fan Multi Air Flow
- Tempered Glass Shelves
- Deodorizer
- Glass door
- Neuro Inverter System

2 & 10
YEARS YEARS
GENERAL WARRANTY COMPRESSOR WARRANTY

COLOURS



Glass Brilliant Black



White

MR-LX68EM

Dimension (mm)
900 (W) x 1798 (H) x 735 (D)

Gross Capacity
630 Litres

Weight (kg)
123

2 & 10
YEARS YEARS
GENERAL WARRANTY COMPRESSOR WARRANTY

COLOURS



Glass Brilliant Black



Glass Stellar Silver

Gross Capacity

F
Freezer Compartment
180 Litres

R
Refrigerator Compartment
333 Litres

V
Vegetable Compartment
117 Litres

Main Features:

- Automatic Ice Maker
- Supercool Chilling Case
- Vitamin Factory
- Door Alarm
- Multi Air Flow
- Deodorizer
- Glass Door
- Frost Free
- Tempered Glass Shelves
- Neuro Inverter System



Mitsubishi Malaysia Sales & Service Sdn Bhd

HEAD OFFICE:

MITSUBISHI ELECTRIC SALES MALAYSIA SDN BHD (197101000755)

Lot 11, Jalan 219, PO Box 1036, 46860 Petaling Jaya

Selangor Darul Ehsan, Malaysia

Hotline: 1-300-13-1303 Fax: 03-7958 2576

Website: www.mitsubishielectricmalaysia.com

Branches:

Penang : Tel: 04-5101838 Fax: 04-5101835

Malacca : Tel: 012-977 9221

Johor : Tel: 07-364 2250 / 07-364 2256

Pahang : Tel: 017-733 1208 Fax: 09-516 2203

Kelantan : Tel: 010-403 2899

Perak : Tel: 012-608 5789

Sarawak : Tel: 016-866 1383

Authorised Dealer:



Mitsubishi Electric Consumer Products and Mitsubishi Electric Shizuoka Works acquired ISO 9001 certification under Series 9000 of the International Standard Organization (ISO) based on a review of Quality Warranties for the production of air conditioning equipment. The plant also acquired environmental management system standard ISO 14001 certification.